

Корпуси типу КТ глибиною 250 мм

| | | 26 | 40 | 53 | 66 | 80 | 106 | |
|----|-------|---------|---------|---------|---------|-----------|-----------|---------|
| | | ◀ 265 ▶ | ◀ 397 ▶ | ◀ 529 ▶ | ◀ 662 ▶ | ◀ 794 ▶ | ◀ 1059 ▶ | |
| 40 | 414 ▶ | | | | | | | |
| | ▶ 414 | 1 * | 1 * | 1 2 * | 1 2 * | 1 2 3 * | 1 2 3 * | |
| | 50 | 514 ▶ | | | | | | |
| | | ▶ 514 | 1 * | 1 * | 1 2 * | 1 2 * | 1 2 3 * | 1 2 3 * |
| 60 | 617 ▶ | | | | | | | |
| | ▶ 617 | 1 * | 1 * | 1 2 * | 1 2 * | 1 2 3 * | 1 2 3 4 * | |
| 80 | 823 ▶ | | | | | | | |
| | ▶ 823 | 1 * | 2 1 * | 1 2 * | 1 2 * | 4 3 2 1 * | 1 2 3 4 * | |

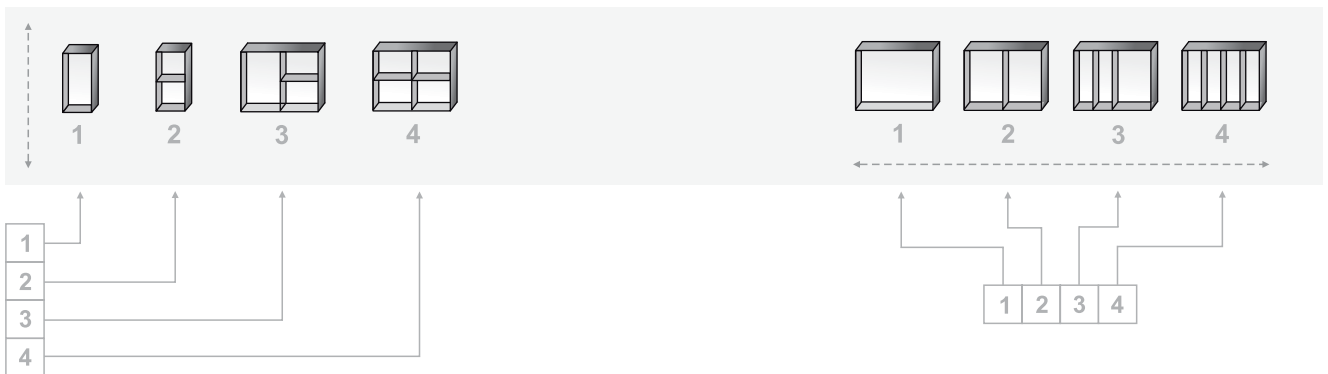























* Можливі варіанти поділу корпусу



Поділ корпусу по вертикалі







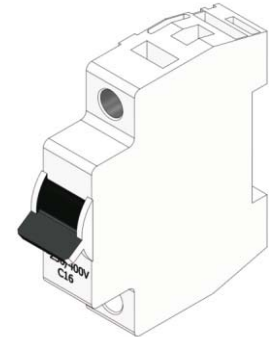













Поділ корпусу по горизонталі

Вибір розміру корпусу відповідно до кількості модулів

| КТ | 26 | 40 | 53 | 66 | 80 | 106 |
|----|--|--|--|--|--|--|
| 40 | 12x2  | 18x2  | 26x2  | 32x2  | 40x2  | 55x2  |
| 50 | 12x3  | 18x3  | 26x3  | 32x3  | 40x3  | 55x3  |
| 60 | 12x4  | 18x4  | 26x4  | 32x4  | 40x4  | 55x4  |
| 80 | 12x5  | 18x5  | 26x5  | 32x5  | 40x5  | 55x5  |





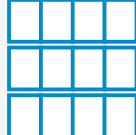
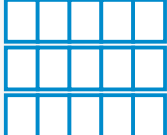
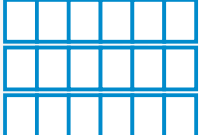

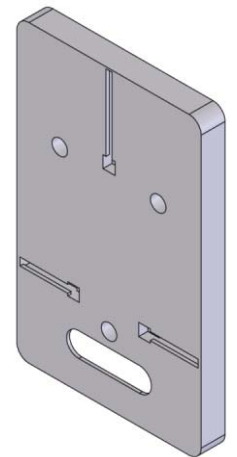

















Вибір розміру корпусу відповідно до кількості плат для однофазних лічильників

| КТ | 26 | 40 | 53 | 66 | 80 | 106 |
|----|---|---|---|---|---|---|
| 40 |  |  |  |  |  |  |
| 50 |  |  |  |  |  |  |
| 60 |  |  |  |  |  |  |
| 80 |  |  |  |  |  |  |





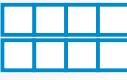

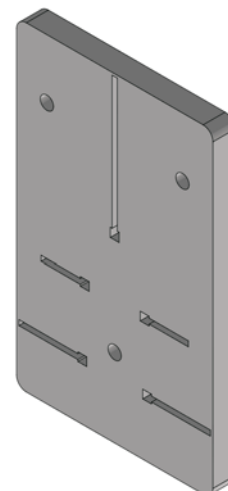



















Вибір розміру корпусу відповідно до кількості плат для трьохфазних лічильників

| КТ | 26 | 40 | 53 | 66 | 80 | 106 |
|----|---|---|---|---|---|---|
| 40 |  |  |  |  |  |  |
| 50 |  |  |  |  |  |  |
| 60 |  |  |  |  |  |  |
| 80 |  |  |  |  |  |  |



Вибір розміру корпусу відповідно до кількості горизонтальних вимикачів-роз'єднувачів 00 габариту

| КТ | 26 | 40 | 53 | 66 | 80 | 106 |
|----|---|---|---|---|--|---|
| 40 |  |  |  |  |  |  |
| 50 |  |  |  |  |  |  |
| 60 |  |  |  |  |  |  |
| 80 |  |  |  |  |  |  |

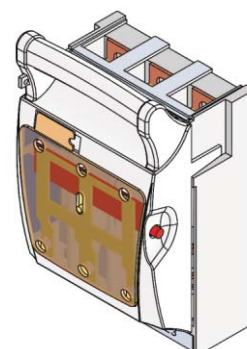

Вибір розміру корпусу відповідно до кількості вертикальних вимикачів-роз'єднувачів 2 габариту

| КТ | 26 | 40 | 53 | 66 | 80 | 106 |
|----|---|---|---|---|--|---|
| 80 |  |  |  |  |  |  |

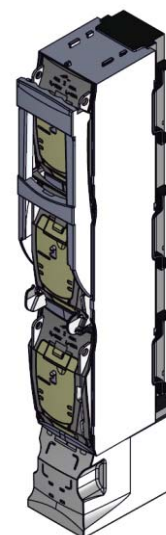

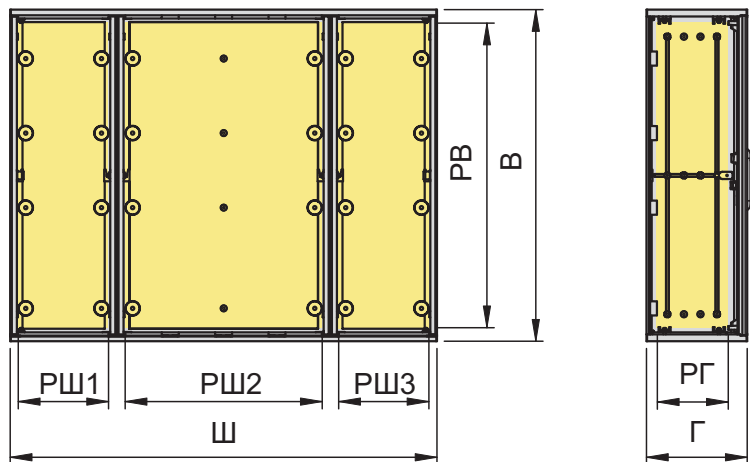
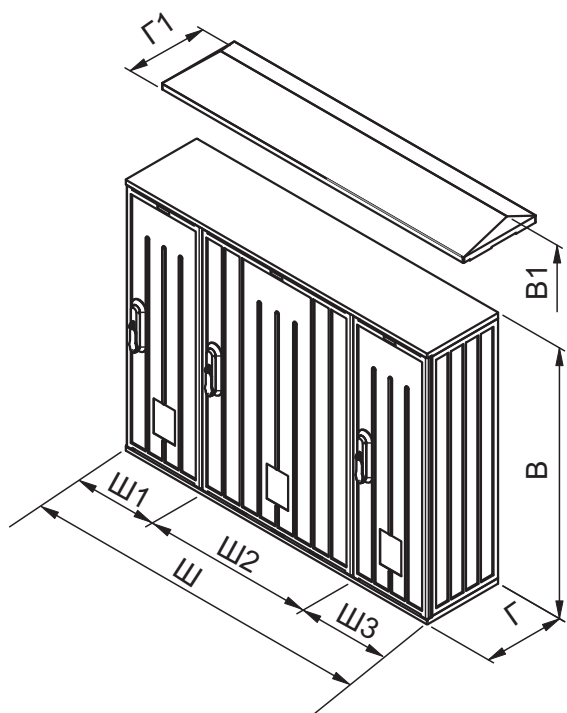

Типи ізоляторів

Висота корпусу 40, 50, 60 см

Висота корпусу 80 см

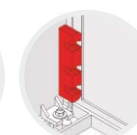
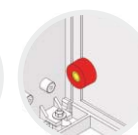
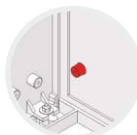

Тип Б

Тип С

Тип М10

Тип А1

| Тип | Тип ізолятора | Ш | В | Г | В1 | Г1 | Ш1 | Ш2 | Ш3 | РШ1 | РШ2 | РШ3 | РВ | РГ | Артикул |
|------------------------|---------------|------|-----|-----|-----|-----|-----|-----|-----|-----|-----|-----|-----|-----|-----------------|
| КТ 84.3 - 2/2/2 П(К) | С | 794 | 411 | 250 | 436 | 255 | 265 | 264 | 265 | 224 | 224 | 224 | 344 | 184 | 0105000179(82) |
| КТ 85.3 - 2/2/2 П(К) | С | 794 | 514 | 250 | 539 | 255 | 265 | 264 | 265 | 224 | 224 | 224 | 447 | 184 | 0105000180(83) |
| КТ 86.3 - 2/2/2 П(К) | С | 794 | 617 | 250 | 642 | 255 | 265 | 264 | 265 | 224 | 224 | 224 | 550 | 184 | 0105000181(84) |
| КТ 88.3 - 2/2/2 П(К) | С | 823 | 617 | 250 | 848 | 255 | 265 | 264 | 265 | 224 | 224 | 224 | 756 | 184 | 0105000185(89) |
| КТ 104.3 - 4/4/2 П(К) | С | 1059 | 411 | 250 | 436 | 255 | 397 | 397 | 265 | 357 | 357 | 224 | 344 | 184 | 0105000545(48) |
| КТ 104.3 - 4/2/4 П(К) | С | 1059 | 414 | 250 | 436 | 255 | 397 | 265 | 397 | 357 | 224 | 357 | 344 | 184 | 0105000559(62) |
| КТ 104.3 - 2/4/4 П(К) | С | 1059 | 411 | 250 | 436 | 255 | 265 | 397 | 397 | 224 | 357 | 357 | 344 | 184 | 0105000573(76) |
| КТ 105.3 - 4/4/2 П(К) | С | 1059 | 514 | 250 | 539 | 255 | 397 | 397 | 265 | 357 | 357 | 224 | 447 | 184 | 0105000546(49) |
| КТ 105.3 - 4/2/4 П(К) | С | 1059 | 514 | 250 | 539 | 255 | 397 | 265 | 397 | 357 | 224 | 357 | 447 | 184 | 0105000560(63) |
| КТ 105.3 - 2/4/4 П(К) | С | 1059 | 514 | 250 | 539 | 255 | 265 | 397 | 397 | 224 | 357 | 357 | 447 | 184 | 0105000574(77) |
| КТ 106.3 - 2/2/5 П(К) | С | 1059 | 617 | 250 | 642 | 255 | 265 | 265 | 529 | 224 | 224 | 489 | 550 | 184 | 0105000473(74) |
| КТ 106.3 - 2/5/2 П(К) | С | 1059 | 617 | 250 | 642 | 255 | 265 | 529 | 265 | 224 | 489 | 224 | 550 | 184 | 0105000483(84) |
| КТ 106.3 - 5/2/2 П(К) | С | 1059 | 617 | 250 | 642 | 255 | 529 | 265 | 265 | 489 | 224 | 224 | 550 | 184 | 0105000493(94) |
| КТ 106.3 - 4/4/2 П(К) | С | 1059 | 617 | 250 | 642 | 255 | 397 | 397 | 265 | 357 | 357 | 224 | 550 | 184 | 0105000547(50) |
| КТ 106.3 - 4/2/4 П(К) | С | 1059 | 617 | 250 | 642 | 255 | 397 | 265 | 397 | 357 | 224 | 357 | 550 | 184 | 0105000561(64) |
| КТ 106.3 - 2/4/4 П(К) | С | 1059 | 617 | 250 | 642 | 255 | 265 | 397 | 397 | 224 | 357 | 357 | 550 | 184 | 0105000575(78) |
| КТ 108.3 - 2/2/5 П(К)* | М10 | 1059 | 823 | 250 | 436 | 255 | 265 | 265 | 529 | 224 | 224 | 489 | 756 | 176 | 0105000477(81) |
| КТ 108.3 - 2/5/2 П(К)* | М10 | 1059 | 823 | 250 | 436 | 255 | 265 | 529 | 265 | 224 | 489 | 224 | 756 | 176 | 0105000487(91) |
| КТ 108.3 - 5/2/2 П(К)* | М10 | 1059 | 823 | 250 | 436 | 255 | 529 | 265 | 265 | 489 | 224 | 224 | 756 | 176 | 0105000497(501) |
| КТ 108.3 - 4/4/2 П(К)* | М10 | 1059 | 823 | 250 | 436 | 255 | 397 | 397 | 265 | 357 | 357 | 224 | 756 | 176 | 0105000553(57) |
| КТ 108.3 - 4/2/4 П(К)* | М10 | 1059 | 823 | 250 | 436 | 255 | 397 | 265 | 397 | 357 | 224 | 357 | 756 | 176 | 0105000567(71) |
| КТ 108.3 - 2/4/4 П(К)* | М10 | 1059 | 823 | 250 | 436 | 255 | 265 | 397 | 397 | 224 | 357 | 357 | 756 | 176 | 0105000581(85) |

* - Корпус може постачатися глибиною 320мм

П - плоский дах

К - нахилений дах