

Корпуси типу КТ глибиною 250 мм

		26	40	53	66	80	106	
		◀ 265 ▶	◀ 397 ▶	◀ 529 ▶	◀ 662 ▶	◀ 794 ▶	◀ 1059 ▶	
40	414 ▶							
	▶ 414	1 *	1 *	1 2 *	1 2 *	1 2 3 *	1 2 3 *	
	50	514 ▶						
		▶ 514	1 *	1 *	1 2 *	1 2 *	1 2 3 *	1 2 3 *
60	617 ▶							
	▶ 617	1 *	1 *	1 2 *	1 2 *	1 2 3 *	1 2 3 4 *	
80	823 ▶							
	▶ 823	1 *	2 1 *	1 2 *	1 2 *	4 3 2 1 *	1 2 3 4 *	

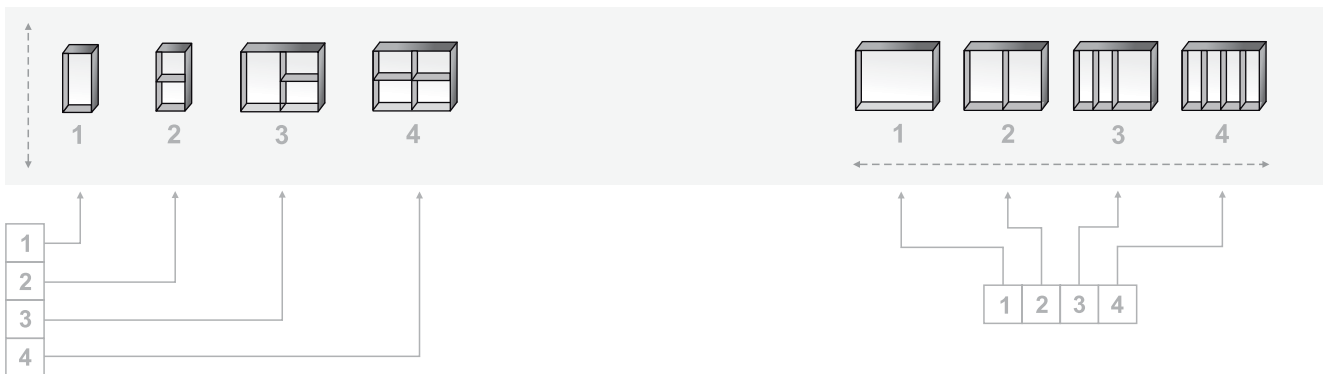























* Можливі варіанти поділу корпусу



Поділ корпусу по вертикалі







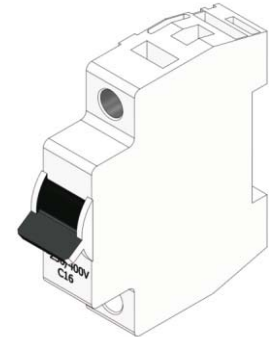













Поділ корпусу по горизонталі

Вибір розміру корпусу відповідно до кількості модулів

КТ	26	40	53	66	80	106
40	12x2 	18x2 	26x2 	32x2 	40x2 	55x2 
50	12x3 	18x3 	26x3 	32x3 	40x3 	55x3 
60	12x4 	18x4 	26x4 	32x4 	40x4 	55x4 
80	12x5 	18x5 	26x5 	32x5 	40x5 	55x5 





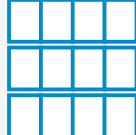
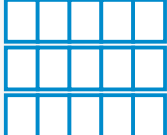
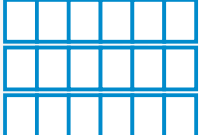

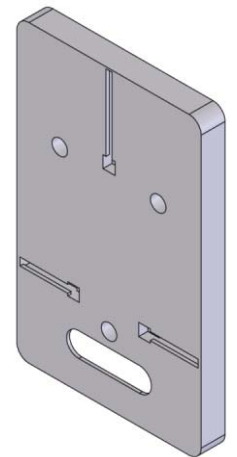



















Вибір розміру корпусу відповідно до кількості плат для однофазних лічильників

КТ	26	40	53	66	80	106
40						
50						
60						
80						







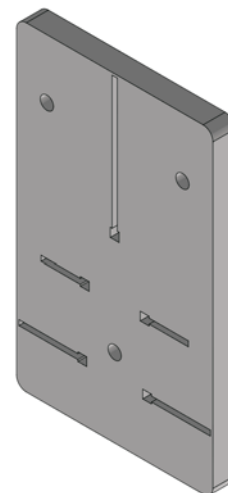



















Вибір розміру корпусу відповідно до кількості плат для трьохфазних лічильників

КТ	26	40	53	66	80	106
40						
50						
60						
80						



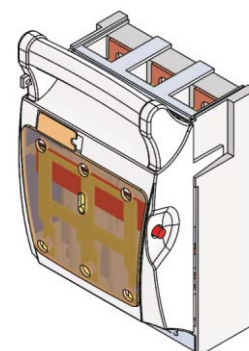

Вибір розміру корпусу відповідно до кількості горизонтальних вимикачів-роз'єднувачів 00 габариту

КТ	26	40	53	66	80	106
40						
50						
60						
80						



Вибір розміру корпусу відповідно до кількості вертикальних вимикачів-роз'єднувачів 2 габариту

КТ	26	40	53	66	80	106
80						

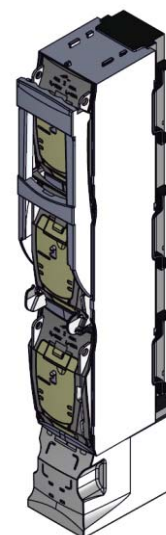

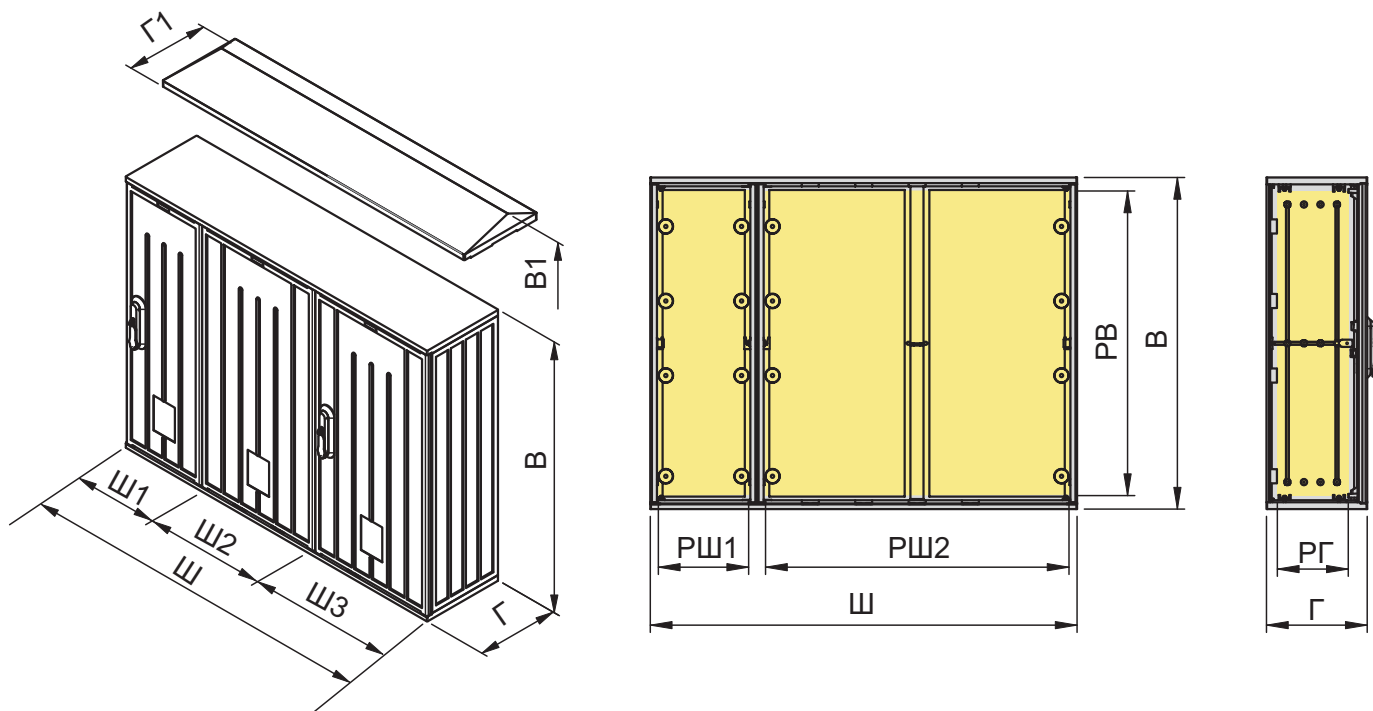

Типи ізоляторів

Висота корпусу 40, 50, 60 см

Висота корпусу 80 см

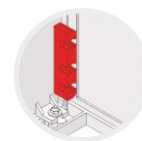
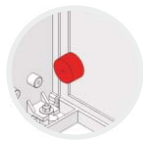

Тип Б

Тип С

Тип М10

Тип А1

Тип	Тип ізолятора	Ш	В	Г	В1	Г1	Ш1	Ш2	Ш3	РШ1	РШ2	РВ	РГ	Артикул
КТ 84.2 - 2/22 П(К)	С	794	411	250	436	255	265	265	264	224	489	344	184	0105000151(54)
КТ 85.2 - 2/22 П(К)	С	794	514	250	539	255	265	265	264	224	489	447	184	0105000152(55)
КТ 86.2 - 2/22 П(К)	С	794	617	250	642	255	265	265	264	224	489	550	184	0105000153(56)
КТ 88.2 - 2/22 П(К)*	М10	794	823	250	848	255	265	265	264	224	489	756	176	0105000159(63)
КТ 104.2 - 4/24 П(К)	С	1059	411	250	436	255	397	265	397	357	622	344	184	0105000389(92)
КТ 104.2 - 4/42 П(К)	С	1059	411	250	436	255	397	397	265	357	622	344	184	0105000403(06)
КТ 104.2 - 2/44 П(К)	С	1059	411	250	436	255	265	397	397	224	753	344	184	0105000445(48)
КТ 105.2 - 4/24 П(К)	С	1059	514	250	539	255	397	265	397	357	622	447	184	0105000390(93)
КТ 105.2 - 4/42 П(К)	С	1059	514	250	539	255	397	397	265	357	622	447	184	0105000404(07)
КТ 105.2 - 2/44 П(К)	С	1059	514	250	539	255	265	397	397	224	753	447	184	0105000446(49)
КТ 106.2 - 4/24 П(К)	С	1059	617	250	642	255	397	265	397	357	622	550	184	0105000391(94)
КТ 106.2 - 4/42 П(К)	С	1059	617	250	642	255	397	397	265	357	622	550	184	0105000405(08)
КТ 106.2 - 2/44 П(К)	С	1059	617	250	642	255	265	397	397	224	753	550	184	0105000447(50)
КТ 108.2 - 4/24 П(К)*	М10	1059	823	250	848	255	397	265	397	357	622	756	176	0105000397(401)
КТ 108.2 - 4/42 П(К)*	М10	1059	823	250	848	255	397	397	265	357	622	756	176	0105000411(15)
КТ 108.2 - 2/44 П(К)*	М10	1059	823	250	848	255	265	397	397	224	753	756	176	0105000453(57)

* - Корпус може постачатися глибиною 320мм

П - плоский дах

К - нахилений дах

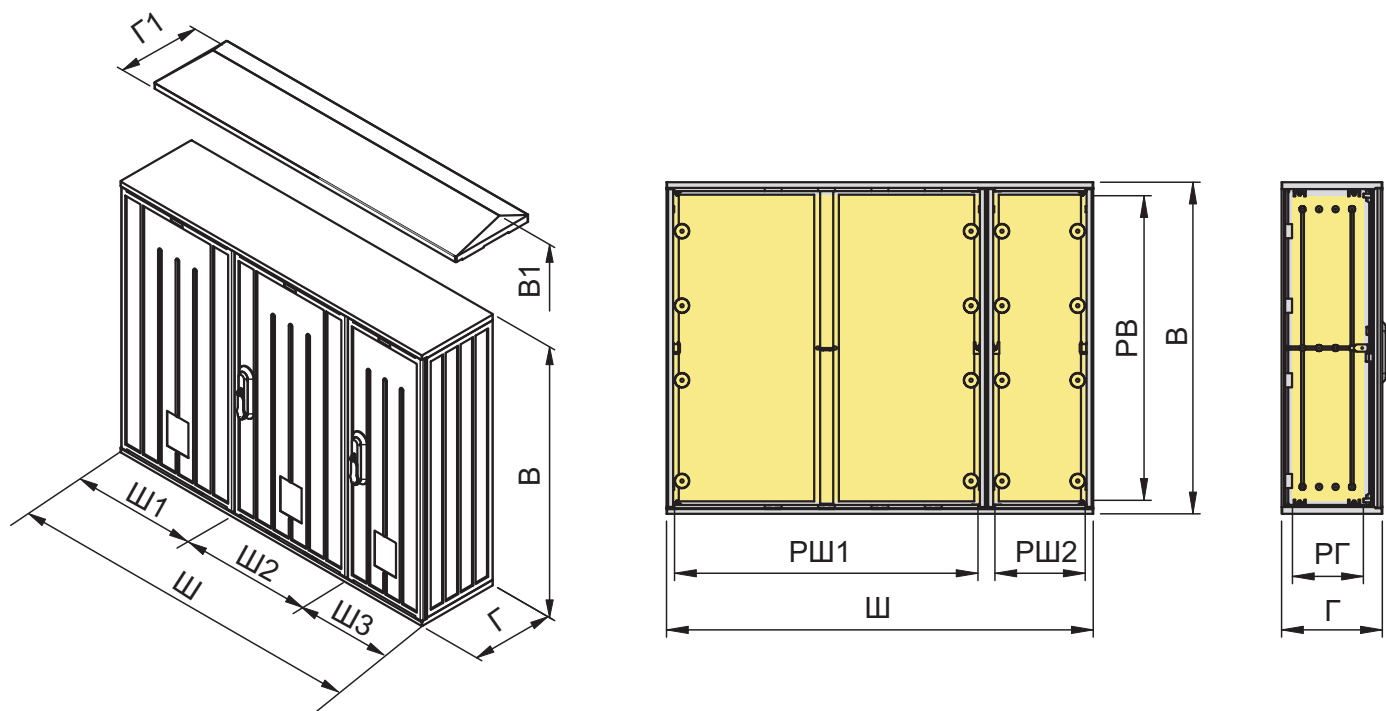

Типи ізоляторів

Висота корпусу 40, 50, 60 см

Висота корпусу 80 см

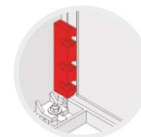
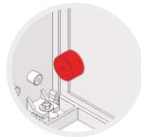

Тип Б

Тип С

Тип М10

Тип А1

Тип	Тип ізолятора	Ш	В	Г	В1	Г1	Ш1	Ш2	Ш3	РШ1	РШ2	РВ	РГ	Артикул
КТ 84.2 - 22/2 П(К)	С	794	411	250	436	255	264	265	265	489	224	344	184	0105000165(68)
КТ 85.2 - 22/2 П(К)	С	794	514	250	539	255	264	265	265	489	224	447	184	0105000166(69)
КТ 86.2 - 22/2 П(К)	С	794	617	250	642	255	264	265	265	489	224	550	184	0105000167(70)
КТ 88.2 - 22/2 П(К)*	М10	794	823	250	848	255	264	265	265	489	224	756	176	0105000173(77)
КТ 104.2 - 24/4 П(К)	С	1059	411	250	436	255	265	397	397	622	357	344	184	0105000417(20)
КТ 104.2 - 42/4 П(К)	С	1059	411	250	436	255	397	265	397	662	357	344	184	0105000431(34)
КТ 104.2 - 44/2 П(К)	С	1059	411	250	436	255	397	397	265	753	224	344	184	0105000459(62)
КТ 105.2 - 24/4 П(К)	С	1059	514	250	539	255	265	397	397	622	357	447	184	0105000418(21)
КТ 105.2 - 42/4 П(К)	С	1059	514	250	539	255	397	265	397	622	357	447	184	0105000432(35)
КТ 105.2 - 44/2 П(К)	С	1059	514	250	539	255	265	397	397	224	753	447	184	0105000460(63)
КТ 106.2 - 24/4 П(К)	С	1059	617	250	642	255	265	397	397	622	357	550	184	0105000419(22)
КТ 106.2 - 42/4 П(К)	С	1059	617	250	642	255	397	265	397	622	357	550	184	0105000433(36)
КТ 106.2 - 44/2 П(К)	С	1059	617	250	642	255	397	397	265	753	224	550	184	0105000461(64)
КТ 108.2 - 24/4 П(К)*	М10	1059	823	250	848	255	265	397	397	622	357	756	176	0105000425(29)
КТ 108.2 - 42/4 П(К)*	М10	1059	823	250	848	255	397	265	397	622	357	756	176	0105000439(43)
КТ 108.2 - 44/2 П(К)*	М10	1059	823	250	848	255	397	397	265	753	224	756	176	0105000467(72)

* - Корпус може постачатися глибиною 320мм

П - плоский дах

К - нахилений дах