

Корпуси типу КТ глибиною 250 мм

		26	40	53	66	80	106
		◀ 265 ▶	◀ 397 ▶	◀ 529 ▶	◀ 662 ▶	◀ 794 ▶	◀ 1059 ▶
40	414 ▶						
		1 *	1 *	1 2 *	1 2 *	1 2 3 *	1 2 3 *
	514 ▶						
		1 *	1 *	1 2 *	1 2 *	1 2 3 *	1 2 3 *
60	617 ▶						
		1 *	1 *	1 2 *	1 2 *	1 2 3 *	1 2 3 4 *
80	823 ▶						
		1 *	2 1 *	1 2 *	1 2 *	4 3 2 1 *	1 2 3 4 *

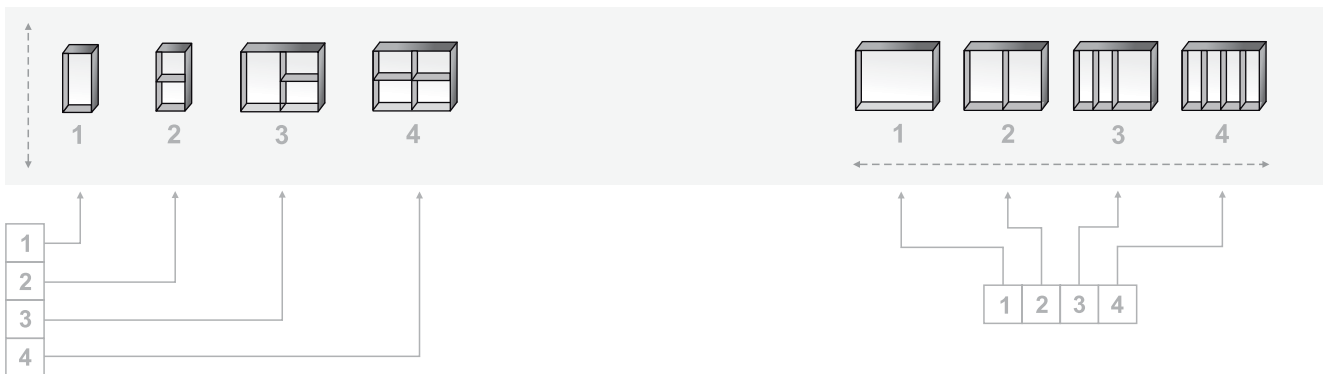























* Можливі варіанти поділу корпусу



Поділ корпусу по вертикалі







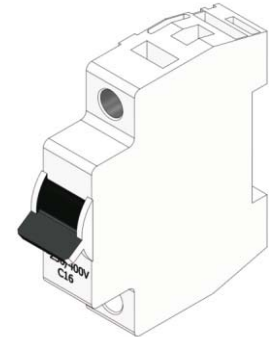













Поділ корпусу по горизонталі

Вибір розміру корпусу відповідно до кількості модулів

КТ	26	40	53	66	80	106
40	12x2 	18x2 	26x2 	32x2 	40x2 	55x2 
50	12x3 	18x3 	26x3 	32x3 	40x3 	55x3 
60	12x4 	18x4 	26x4 	32x4 	40x4 	55x4 
80	12x5 	18x5 	26x5 	32x5 	40x5 	55x5 





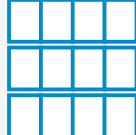
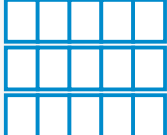
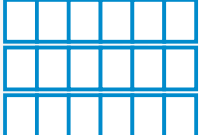

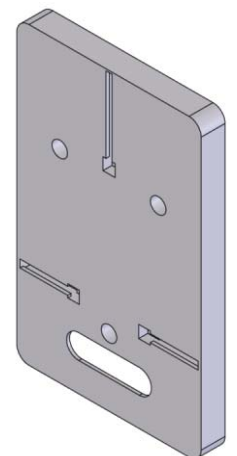















Вибір розміру корпусу відповідно до кількості плат для однофазних лічильників

КТ	26	40	53	66	80	106
40						
50						
60						
80						



























Вибір розміру корпусу відповідно до кількості плат для трьохфазних лічильників

КТ	26	40	53	66	80	106
40						
50						
60						
80						



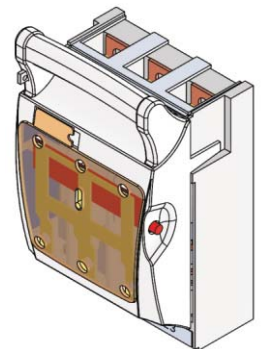

Вибір розміру корпусу відповідно до кількості горизонтальних вимикачів-роз'єднувачів 00 габариту

КТ	26	40	53	66	80	106
40						
50						
60						
80						



Вибір розміру корпусу відповідно до кількості вертикальних вимикачів-роз'єднувачів 2 габариту

КТ	26	40	53	66	80	106
80						

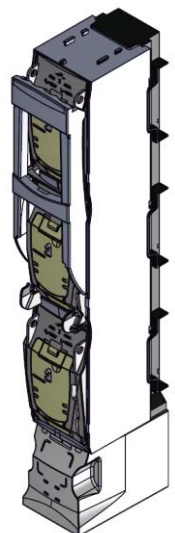

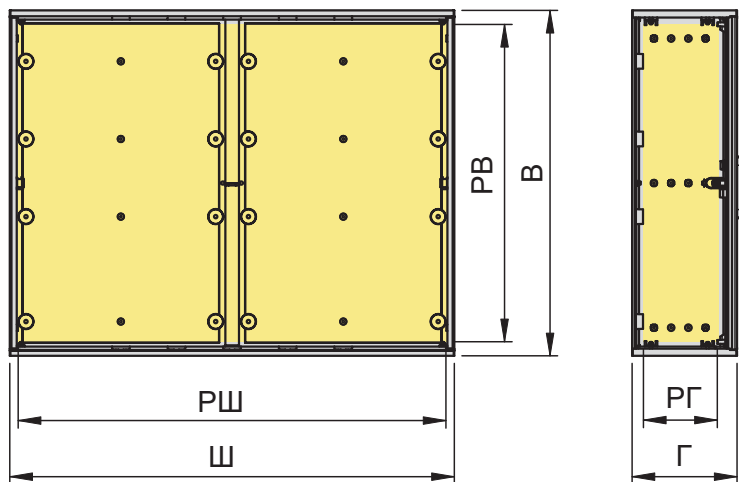
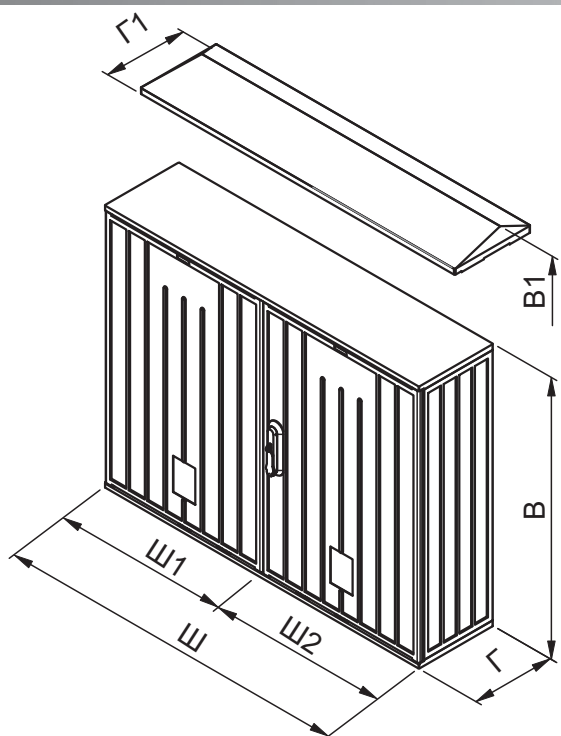

Типи ізоляторів

Висота корпусу 40, 50, 60 см

Висота корпусу 80 см

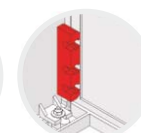
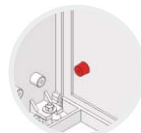

Тип Б

Тип С

Тип М10

Тип А1

Тип	Тип ізолятора	Ш	В	Г	В1	Г1	Ш1	Ш2	РШ	РВ	РГ	Артикул
КТ 54.1 - 22 П(К)	С	529	411	250	436	255	264	265	489	344	184	0105000039(42)
КТ 55.1 - 22 П(К)	С	529	514	250	539	255	264	265	489	447	184	0105000040(43)
КТ 56.1 - 22П(К)	С	529	617	250	642	255	264	265	489	550	184	0105000041(44)
КТ 58.1 - 22 П(К)*	М10	529	823	250	848	255	264	265	489	756	176	0105000047(51)
КТ 64.1 - 24 П(К)	С	662	411	250	436	255	264	398	662	344	184	0105000067(70)
КТ 64.1 - 42 П(К)	С	662	411	250	436	255	398	264	662	344	184	0105000081(84)
КТ 65.1 - 24 П(К)	С	662	514	250	539	255	264	398	662	447	184	0105000068(71)
КТ 65.1 - 42 П(К)	С	662	514	250	539	255	398	264	662	447	184	0105000082(85)
КТ 66.1 - 24 П(К)	С	662	617	250	642	255	264	398	662	550	184	0105000069(72)
КТ 66.1 - 42 П(К)	С	662	617	250	642	255	398	264	662	550	184	0105000083(86)
КТ 68.1 - 24 П(К)*	М10	662	823	250	848	255	264	398	662	756	176	0105000075(79)
КТ 68.1 - 42 П(К)*	М10	662	823	250	848	255	398	264	662	756	176	0105000089(93)
КТ 84.1 - 44 П(К)	С	794	411	250	436	255	397	397	753	344	184	0105000123(26)
КТ 85.1 - 44 П(К)	С	794	514	250	539	255	397	397	753	447	184	0105000124(27)
КТ 86.1 - 44 П(К)	С	794	617	250	642	255	397	397	753	550	184	0105000125(28)
КТ 86.1 - 25 П(К)	С	794	617	250	642	255	264	530	753	550	184	0105000317(18)
КТ 86.1 - 52 П(К)	С	794	617	250	642	255	530	264	753	550	184	0105000327(28)
КТ 88.1 - 44 П(К)*	М10	794	823	250	848	255	397	397	753	756	176	0105000131(35)
КТ 88.1 - 25 П(К)*	М10	794	823	250	848	255	264	530	753	756	176	0105000321(25)
КТ 88.1 - 52 П(К)*	М10	794	823	250	848	255	530	264	753	756	176	0105000331(35)
КТ 106.1 - 55 П(К)	С	1059	617	250	642	255	529	531	1019	550	184	0105000249(50)
КТ 108.1 - 55 П(К)*	М10	1059	823	250	848	255	529	531	1019	550	176	0105000253(57)
КТ 108.1 - 46 П(К)*	М10	1059	823	250	848	255	397	662	1019	550	176	0105000359(63)
КТ 108.1 - 64 П(К)*	М10	1059	823	250	848	255	662	397	1019	550	176	0105000367(71)

* - Корпус може постачатися глибиною 320мм

П - плоский дах

К - нахилений дах